



Operating and Basic Maintenance Instructions

 This document contains important Health and Safety Advice and must remain with the vehicle at all times.

Main Feature Locations

1. Access door to electrics, pneumatics, hydraulic oil tank and auxiliary engine fuel tank.
2. Locker. Water tank filler, in right hand side.
3. Low pressure water pump and valves.
4. Water tank under hopper.
5. Auxiliary engine access ladder. On kerb side of vehicle.
6. Central brush (wide sweep).
7. Rear door open/close hydraulic ram.
8. High pressure water hose reel (option). On off side of vehicle.
9. High pressure lance. Accessed from off side of the vehicle.

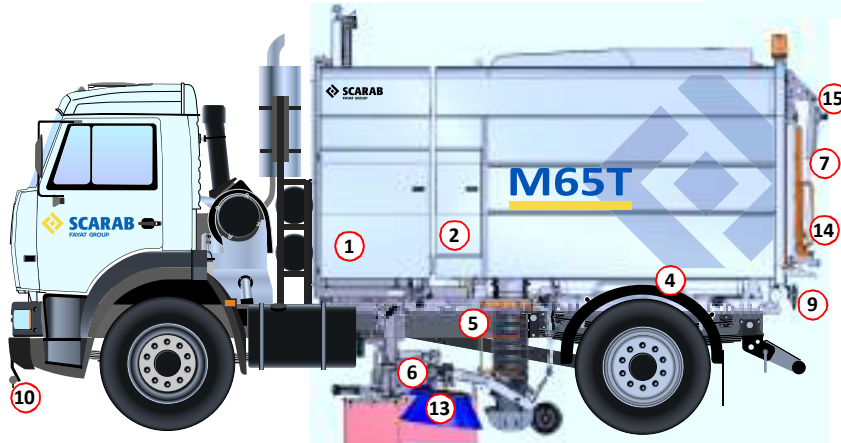
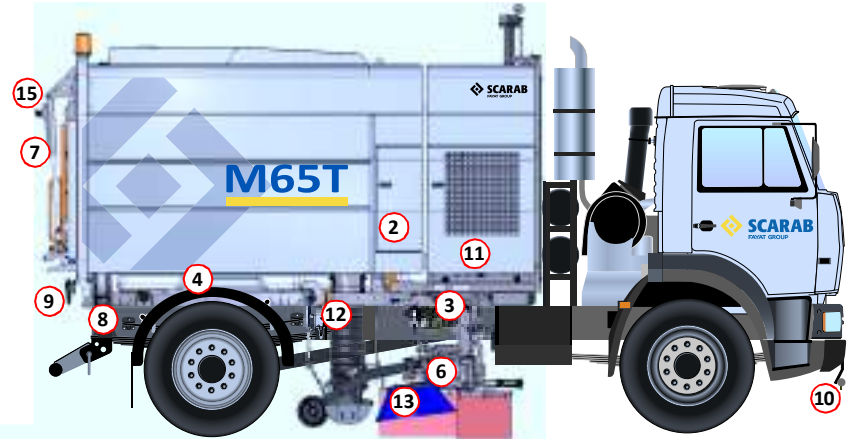

10. Low pressure and/or high pressure spray bar.
11. Hydraulic valve block and hydraulic cooler access door.
12. Auxiliary hand pump.
13. Side brush assembly.
14. Rear loading hatch access ladder. Normally on kerb side of vehicle.
15. Rear camera.

i Dual sweep machine shown.
Shown without rear wander hose.

Scarab M65T

Skid Mounted Road Sweeper

Operating and Basic Maintenance Handbook

Includes information on Stage V engines

Part No. SCAZ043468

Version: 1.6.0116th November 2020

When re-ordering this document, please quote the above Part No.

This manual is published by the Technical Publications Department of Scarab Sweepers Ltd. and every effort is made to ensure that the information it contains is correct at the time of publication. Due to a policy of continuous development, however, the Company reserves the right to alter the specification and to supply when so altered without reference to illustrations and descriptions in this manual.

Scarab Sweepers Ltd.
Pattenden Lane, Marden, Tonbridge, Kent, TN12 9QD, England
T: + 44 (0) 1622 831 006
E: scarab@scarab-sales.com - W: www.scarab-sweepers.com
Registered in England No.1823459 - VAT No. GB 374 5002 68
Registered Office: Pattenden Lane, Marden, Tonbridge, Kent TN12 9QD, England

Copyright ©2020 Scarab Sweepers Limited

General Information

Typical Capacities

| | |
|---|--------------------|
| Hopper Gross Volume | 6.35m ³ |
| Fuel Tank Capacity (Auxiliary Engine) | 120 litres |
| Hydraulic Tank Capacity | 45 litres |
| Water Tank Capacity | 1250 litres |

Noise Levels

| | |
|----------------|---|
| In cab | Between 70 - 84 dB(A) dependant on operating speed. |
| External | Maximum L _{WA} of 114 dB(A) in accordance with directive 2000/14/EC. |

Vibration

All dynamic prime moving components are resiliently mounted to minimise vibrations. In accordance with 2006/42/EC as amended.

| | |
|------------------|---|
| Whole body | Equipment does not exceed 0.5 m/s ² (RMS, weighted). |
| Hand & Arm | Equipment does not exceed 2.5 m/s ² (VTV). |



In view of the fact that many variables such as chassis and machine specification affect the weight and dimensions of the finished vehicle, it is not possible to quote these precise details. If this type of information is required then please contact our Technical Sales Team giving details of your intended chassis and other relevant information.

Identification Plates

The Serial Number Plate is located at the base of the enclosure on the left hand side of the sweepers chassis unit. The serial number will compose of a 4 or 5 digits only, for example 1234 or 56789.

For location of the chassis units VIN number and chassis number please refer to the chassis manufactures' documentation.

Limitations of Use

The Scarab M65T is classified as a heavy duty suction road sweeper and, as such, is intended only for operation in the sweeping and associated roles for which it has been expressly designed for.

Applicability

This manual covers the operating requirements of the Scarab M65T Road Sweeper with the CAN Bus operating system.

DEUTZ Auxiliary Engine

The sweeper will either utilise a DEUTZ TCD 3.6 EU Stage IIIB engine or a DEUTZ TCD 3.6 Stage 5 engine, which drives pumps to operate all hydraulic sweeper functions. This manual does not cover the DEUTZ auxiliary engine that is used in this sweeper.



Please consult the DEUTZ engine manual supplied with the machine for more detail and in the case of issues not covered in the manual then contact DEUTZ.

WARNINGS

Starting

 **Warning - Voltage Sensitive Components**
Never start the auxiliary engine with a fast charger. If batteries are not charged then use a fresh set of batteries.

 **WARNING - DEUTZ TCD 3.6 EU Stage IIIB and DEUTZ TCD 3.6 Stage 5 engine fuel outage or fuel filters changed.**
Serious damage will result to the high pressure fuel pump if the following procedure is not followed after running out of fuel or changing the fuel filters.

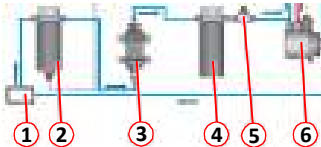
| | | | |
|---|---|---|---|
| 1. Switch ignition ON. DO NOT CRANK ENGINE | 2. Wait 20 seconds. | 3. Turn ignition OFF. | 4. Repeat 4 times. |
|  |  |  | X 4 |
|  | | | 1 Fuel tank 2 Primary filter 3 Fuel pump 4 Secondary filter 5 Low pressure sensor 6 High pressure pump |

Other Electrical Equipment

 **CB radios and other electrical equipment used within the cab should be properly suppressed (EMC) to prevent the possibility of interference in the sweeper's electronic system.**

Towing

 **If towing is necessary then please refer to the chassis manufacturers' documentation for details on towing recommendations.**

Table of Contents

| | |
|----------------------------------|----|
| Main Feature Locations | 2 |
| General Information | 4 |
| Typical Capacities | 4 |
| Noise Levels | 4 |
| Vibration | 4 |
| Identification Plates | 4 |
| Limitations of Use | 4 |
| Applicability | 4 |
| DEUTZ Auxiliary Engine | 5 |
| Starting | 5 |
| Other Electrical Equipment | 5 |
| Towing | 5 |
| Table of Contents | 6 |
| Health and Safety Advice | 10 |
| Hazard Awareness | 11 |
| Safety Precautions | 11 |
| Operating Advice | 12 |
| Safety Props | 13 |
| Hopper Prop | 13 |
| Rear Door Prop | 13 |

| | |
|--|-----|
| The CAN Bus System | .14 |
| Switches | .14 |
| Main Control Panel Switch Functions | .15 |
| Auxiliary Control Panel Switch Functions | .16 |
| Multi Function Lever | .16 |
| Remote Control Switch Box Functions | .17 |
| The LCD Monitor | .18 |
| Additional Controls and Instruments | .19 |
| Air Pressure Regulator | .19 |
| Air Pressure Gauge | .19 |
| Overhead Boom Switch | .19 |
| Operating In Sweep Mode | .20 |
| Starting the Auxiliary Engine | .20 |
| Suction Fan Boost | .21 |
| Sweeping | .21 |
| Exiting Sweep Mode/Stopping the Auxiliary Engine | .22 |
| Discharging the Hopper (Tipping) | .23 |
| Rear Door Operation | .24 |
| Rear Door Prop | .24 |
| Auxiliary Hand Pump | .25 |
| Wander Hose | .26 |
| Inspection Hatch | .26 |
| Overhead Boom | .27 |

Assembly of overhead boom27

Stowing the overhead boom27

Dust Suppression System28

 Water Tank Filling28

 Low Pressure Water System28

 Draining the System28

High Pressure Water System29

 Retractable Hose29

 Draining the System29

Suction Path Blockage Clearance30

Recommended Operator Routine Maintenance32

Key Maintenance Procedures33

 Cleaning the Suction Fan and Screen33

 Auxiliary Engine33

 Engine Access34

 Engine Oil34

 Engine Coolant35

 Hydraulic Oil Tank36

 Filling the Fuel Tank37

 Suction Nozzle Clearances38

 Side Brushes38

 Removing and Cleaning Water Strainer Elements39

 Manual Greasing and Lubrication40

| | |
|--|-----|
| DPF regeneration | .41 |
| DPF regeneration prerequisites | .41 |
| DPF regeneration process | .41 |
| Regeneration process completion | .41 |
| LCD Monitor Screen | .42 |
| Start Up/Main/Sweep mode Screen | .42 |
| Button function | .42 |
| Menu Screen | .43 |
| Hours worked | .44 |
| Driver fault codes | .44 |
| CAN error screen | .45 |
| Driver fault codes | .45 |
| EDC - Vehicle values | .46 |
| After-treatment | .46 |
| EOL Test/Regen | .47 |
| Screen Settings | .47 |
| Screen Brightness Setting | .48 |
| Time/Date Setting | .48 |
| Rear Camera | .49 |
| Information | .49 |
| Button Checks | .50 |
| Main Control Panel Button Check | .50 |
| Auxiliary Control Panel Button Check | .51 |
| Options Screen | .51 |
| Operator Notes | .52 |

Health and Safety Advice

 **In the interests of your Health and Safety, it is important that the following points are followed all the time.**

- Only trained operatives should be allowed to drive or work on this machine.
- Before driving this machine ensure that all relevant machine checks have been carried out and that all equipment is stowed.
- Do not overload the hopper.
- Do not drive the machine with the hopper in the raised position even if the hopper is empty.
- Never work under a raised cab, hopper or rear door without the appropriate safety prop in the correct position.
- Before operating the hopper or rear door controls, ensure that there is sufficient clearance and that it is safe to do so. Ensure that all personnel are clear of the rear door.
- Before working on the machine.
Position the machine on firm, level ground, apply the handbrake, stop both engines and remove the ignition key.
- Always wear the appropriate personnel protective equipment (PPE) when operating or working on the machine.
- Before starting engines ensure that all controls are switched off and the machine is in neutral.
- Keep long hair, loose clothing and hands clear of moving parts.
- High pressure water can be hazardous, always wear suitable face protection when operating the high pressure water pump and when using the high pressure water lance.
Do not direct the water jet at other persons.
Beware of electrical installations on public buildings and lampposts etc.
Use extreme caution when using in public places.
- The drivers seat should be correctly adjusted while the vehicle is stationary to give the driver a good posture whilst the vehicle is being driven.
- The mirrors should be adjusted while the vehicle is stationary to give the driver a good all round of the sides and the sweeping equipment.
- When operating the machine in any mode always be aware of objects and people in the immediate vicinity, especially at the rear of the machine when reversing.
- Whatever the situation, remember that the rules of traffic and road safety must always be observed and obeyed.
- While operating this machine the safety and well being of other people around the machine are the sole responsibility of the driver/operator.
- Never ride in/on any part of the machine other than in the drivers cab.

 *The universal safety symbol along with red text is used throughout this manual and when encountered the related information must be adhered to.*

 *Refers to important information.*

 *Identifies cautionary information and specific procedures when required.*

 *Refers to visual examination to confirm the condition or status of a specific item.*

 **Remember, failure to comply could result in serious injury.**

Hazard Awareness

All operators and workshop personnel should be aware of the physical and biological risks that are inherent in the operation of a road sweeper. The risks fall into two main categories as follows:-

- Risks represented by the machine and its various systems.
- Risks represented by the sweeper’s operating environment.

Both have the potential for exposure to a variety of hazards, ranging from hot surfaces to infectious diseases, that can occur during day-to-day operation, while carrying out adjustments or when involved in the general maintenance and servicing activities on the machine.

Typical machine related hazards are as follows:-

- Exposure to hot surfaces and sharp edges.
- Exposure to moving parts.
- Exposure to various fluids, including some that are hot and/or pressurised.
- Exposure to surface contamination resulting from general operating conditions.

Typical environmental hazards are as follows:-







- Exposure to sharp objects, e.g. broken glass, discarded hypodermic syringes/needles, while operating or working on the machine.
- Exposure to various infectious diseases, e.g. Legionnaire’s, Leptospirosis, Weil’s, Hepatitis, Tetanus, while operating or working on the machine.

Safety Precautions

When using external equipment such as the high pressure water lance, or when dealing with potentially hazardous situations while sweeping, e.g. unblocking a suction nozzle, always wear the appropriate personnel protective equipment (PPE) and exercise extreme caution if required to handle any of the material being swept.

Before working on the machine, subject it to a thorough steam cleaning of high pressure hot water wash using appropriate detergents etc.

Even after taking all reasonable steps to reduce the risk from the hazards described, always wear the appropriate personnel protective equipment (PPE) when carrying out sweeping duties or when working on the machine. This includes the following items:-

| | |
|---|--|
|  Safety gloves, including where necessary cut resistant knitted Kevlar. |  Earplugs or ear defenders as appropriate. |
|  Safety boots or shoes with protective soles and toecaps. |  Eye/face protection, if necessary full face mask with under chin lip. |
|  Respiratory masks. |  High visibility jackets or waistcoats. |

Operating Advice

Please remember, the information provided in this manual is designed to ensure that the Scarab sweeper operates both safely and efficiently.

The design of the machine is for the removal of spoil on traffic or pedestrian areas also litter collection using the wander hose if fitted.

A poorly maintained machine will become unreliable, inefficient and potentially dangerous. Always observe the recommended maintenance and safety related advice provided.

i *Unless it is wet or raining, ALWAYS use the low pressure water spray system when sweeping. This will not only reduce the amount of dust generated, it will also ensure a more efficient collection of material. This is because wet material is heavier and will drop more readily from the air stream in the hopper. If swept dry, material will pass through the screen wearing out the suction fan blades on its way back out to the environment behind you.*

Operators should be trained in the following elements:-

- Health and Safety observations/notices.
- Driving to and from place to be swept (transit driving).
- In cab and external controls.
- Safety prop use, cab, rear door and hopper.
- Brush setting.
- Nozzle flap adjustment.
- Correct sweeping operations.
- Low and high pressure water systems.
- Load discharge (tipping).
- Daily, weekly maintenance schedules.
- End of day cleaning, i.e. suction fan, fan screen and machine body.

Operator training can be provided by Scarab Sweepers upon request.

⚠ **The USB connection in the LCD monitor is for uploading/downloading machine related information and must not be used for anything else.**

i *It is the responsibility of employers to carry out their own risk assessment of the machine, operators or other persons affected by the machine and equipment.*

i *Various safety, hazard and user information labels are fixed to the machine. These must be observed.*

i *Only personnel qualified in the relevant disciplines should be allowed to work on any of the machines hydraulic systems.*

i *For information regarding vehicle/chassis operation and maintenance, please refer to chassis manufactures' handbook.*

Safety Props

Rear Door Prop

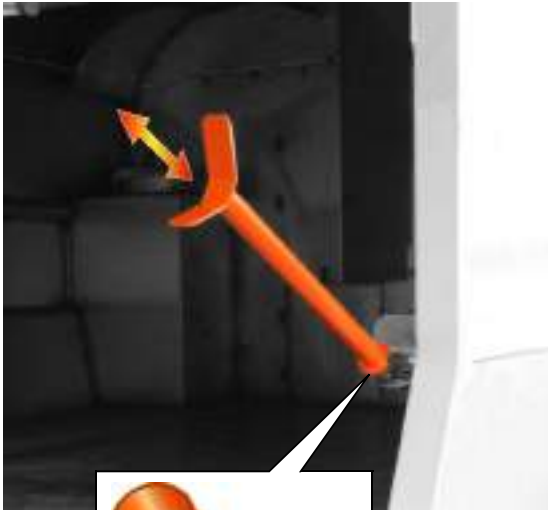

When inserting the door prop, ensure it is correctly positioned in the locating slot.

Hopper Prop



Ensure the hopper safety prop has completely deployed when the hopper is in the raised position.

Never work under a partially raised hopper or if the hopper safety prop is not fully deployed.

The CAN Bus System

The CAN Bus system comprises of two control panels, main and auxiliary, an LCD monitor and a number of control nodes. The system controls and monitors all the sweeping functions and maintains a log of various operating parameters such as operating hours and fault conditions that may occur.

Switches

The various types of switch function on the main and auxiliary control panels are colour coded as follows:-

- AMBER** = Electrical functions such as lighting.
- RED** = Critical functions, e.g. Start/stop auxiliary engine and sweep mode.
- GREEN** = Sweeping functions.
- BLUE** = Water Spray functions.

Each switch will illuminate a function related symbol on the LCD monitor, only installed equipment will be displayed. Each symbol is greyed out until its switch is activated. When a switch is activated the appropriate symbol will illuminate according to system status as illustrated below:-

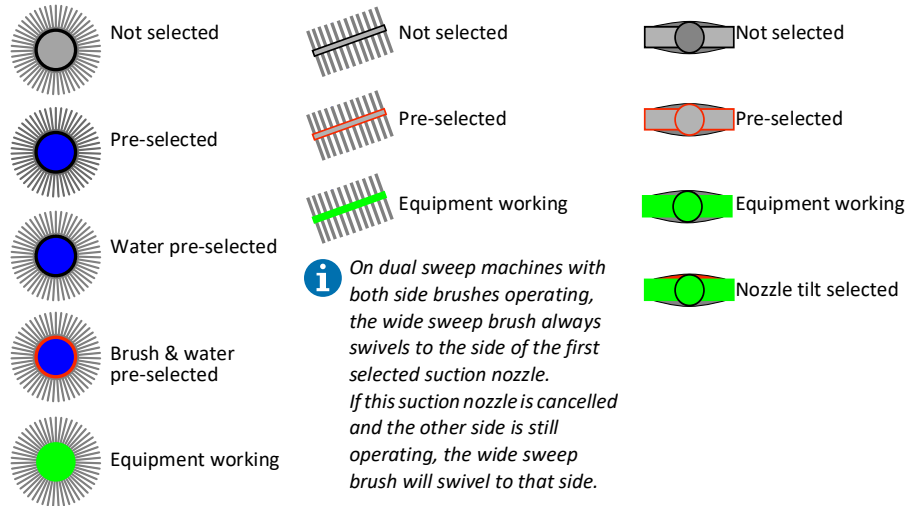
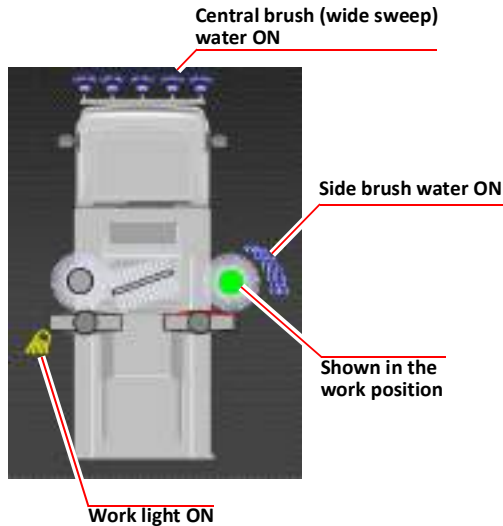

Main Control Panel Switch Functions

i Switch functions are described from left to right and top to bottom.

F1 F2 F1 and F2 - Press to activate special options.

⏻ System Start/Sweep Mode - Press to start/stop auxiliary engine and sweep mode.

⏪ Brush Speed (-) - Press to decrease brush speed. Brush remains at chosen speed until reset.

⏩ Brush Speed (+) - Press to increase brush speed. Brush remains at chosen speed until reset.

⏪ ⏩ Left/Right Side Brush - Press to start/stop the side brush.

⏴ ⏵ Left/Right Suction Nozzle - Press to lower/raise the suction nozzle.

⏴ ⏵ Central Brush (Wide Sweep) - Press to start/stop the central brush (wide sweep).

💡 Left/Right Work Lights - Press to switch on/off the work light.

💧 ⏴ ⏵ Left/Right Side Brush/Nozzle Water - Press to switch on/off water for side brushes and nozzles.

💧 ⏴ ⏵ Central Brush (Wide Sweep) Water - Press to switch on/off water for central brush (wide sweep).









⏴ ⏩ Decrease/Increase Auxiliary Engine Speed - Press to decrease or increase auxiliary engine speed.

💧 ⏴ ⏵ Left/Right Suction Nozzle Additional Water * - Press to start/stop additional suction nozzle water.

* = Option.



Auxiliary Control Panel Switch Functions

-  *Switch functions are described from left to right and top to bottom.*
-  **High Pressure Water Pump *** - Press to switch on/off the high pressure water pump.
-  **Suction Fan** - Press to start the suction fan.
-  **Cruise Control** - Not applicable.
-  **Suction Nozzle Tilt (Locking Mode)** - Press to tilt and lock the suction nozzle for larger items.
-  **Suction Fan 'BOOST'** - With the suction fan on, press to activate the fan boost mode.
-  **Favourite Setting** - Press to memorise your preferred sweeping setup. Hold the switch down until a 'beep' sounds. Thereafter, whenever the switch is pressed at system start-up, the memorised configuration will pre-selected/restarted. Repeat to override with another configuration.
-  *If sequential brush lift option is fitted and active then pressing the favourite button while sweeping will raise and stow all sweep gear immediately and bypass the delay. See pages 42 & 51.*

Multi Function Lever

- ON** - Moving lever to the ON position deploys all selected sweeping equipment.
- OFF** - Moving lever to the OFF position, stops and raises all sweeping equipment.
- Side Brush** - Whilst the lever is in the ON position the lever can be moved to the left and right to operate the side brushes.
On right hand drive vehicles move the lever to the right to swing the side brushes out and move the lever to the left to swing the side brushes in.
On left hand drive vehicles move the lever to the left to swing the side brushes out and move the lever to the right to swing the side brushes in.
- Nozzle Tilt** - Whilst is in the ON position the lever can be moved back/downward to momentarily tilt open the suction nozzle or to close the suction nozzle if in the 'LOCKED' position.

* = Option



Remote Control Switch Box Functions

The hopper raise/lower and rear door open/close switches are located on the remote control switch box. This is stowed in the cab, between the drivers seat and the cab door, it is connected to a socket via a coiled lead.

⚠ In the interests of health and safety and to avoid possible damage to the sweeper and/or adjacent structures, it is essential that the remote controls are not activated within the cab. Always use outside of the machine from a vantage point that affords a good view of the machine and its immediate surroundings. Wear a high visibility jacket/waistcoat .

 **Hopper Raise** - Press and hold to raise the hopper.

⚠ The hopper safety prop should always be in the deployed position when the hopper is in the raised position. Failure to do so could result in serious injury. See page 13.

 **Hopper Lower** - Press and hold to lower the hopper.

⚠ Ensure that the hopper safety prop is returned to its stowage position before attempting to lower the hopper and no obstructions are present under the hopper. Failure to do so could result in damage to the machine and/or serious injury. See page 13.

 **Rear Door Open** - Press and hold to open the rear door.

i *Ensure that the suction fan has been switched off before attempting to open the rear door because the fan creates a vacuum within the hopper space preventing the door from being opened.*

⚠ The rear door safety prop must be in the deployed position whenever working under the rear door. See page 13.

 **Rear Door Close** - Press and hold until the rear door is closed and has finished its latching cycle. Only works when hopper is fully down. See page 24.

⚠ The rear door safety prop must be removed and no obstructions are present before lowering the rear door. See page 13.



 **Option.**

SAFETY INTERLOCK

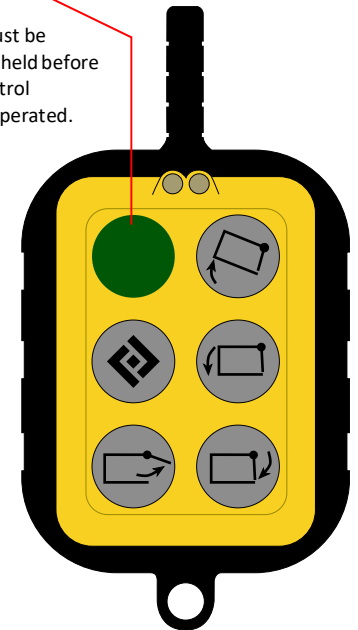
This switch must be pressed in and held before any of the control switches are operated.



The LCD Monitor

The sweeping monitor displays information on the current status of the sweeper while it is in sweep mode, by indicating which items of equipment are active, plus other relevant information i.e. fluid levels, fan speed and temperatures, it also alerts the user to any warnings by means of appropriate flashing symbols and, when appropriate, a warning buzzer. For warnings identified by , stop and investigate the cause. The accompanying illustration shows the range of information/alert symbols that can be displayed, however it should be noted that warning symbols (*) only illuminate when a specific condition occurs. If any of the following DEUTZ engine faults occur the  will flash and the warning buzzer will pulse, stop and investigate the cause. *Low engine coolant, air filter blocked, water in fuel, engine protection lamp (amber), engine stop lamp (red), oil pressure and high coolant temperature.*

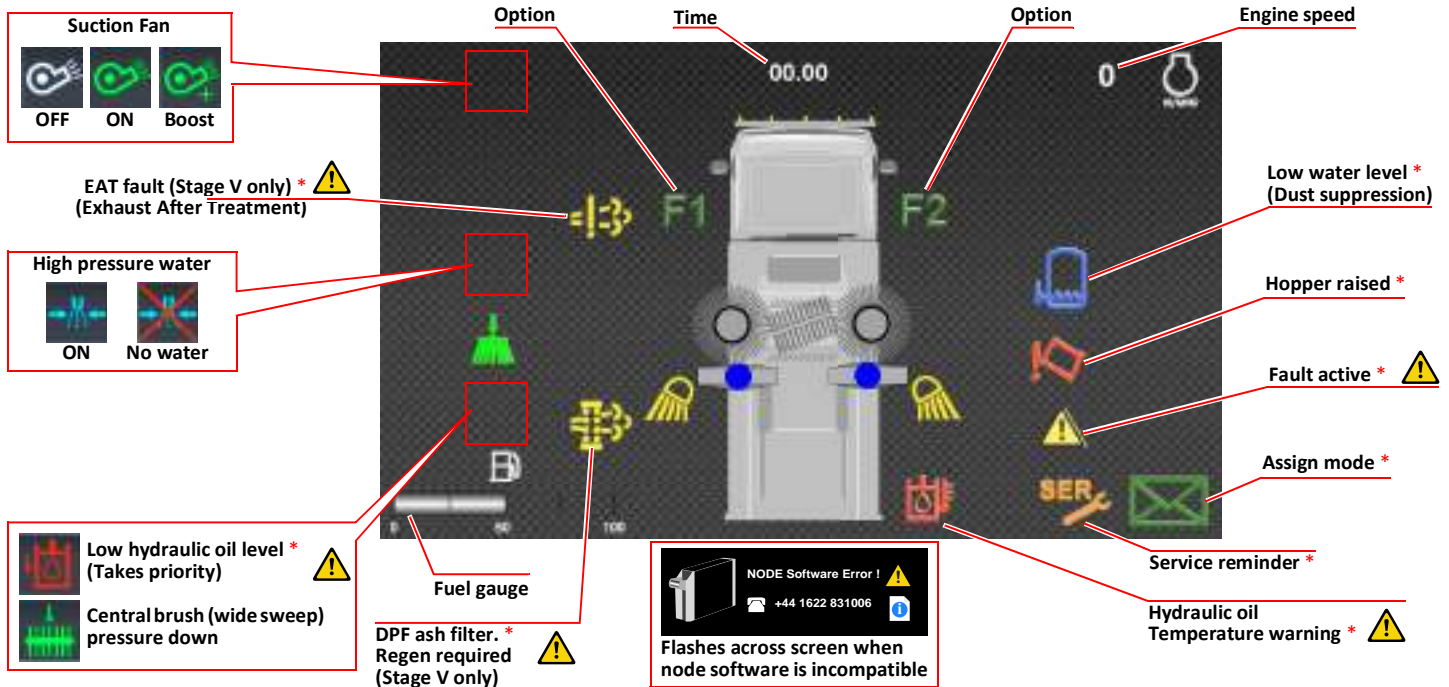

Additional Controls and Instruments

⚠ *Do not exceed a pressure of 2.5 bar when adjusting brush pressure settings. Failure to comply will result in drastically reduced brush life.*

Air Pressure Regulator

Used to adjust the amount of up/down thrust applied to the brush(es).

Air Pressure Gauge

Indicates the amount of pressure being applied to the brush(es).

The above functions are only effective while the relevant brushes are fully deployed.

Overhead Boom Switch

Used to turn on and off the overhead boom function. When switched on the system will raise the auxiliary engine speed to 1900 rpm, raising the suction fan speed proportionally and engage the water valve for the overhead boom dust suppression.

Location of the switch is normally next to the engine bay access ladder.

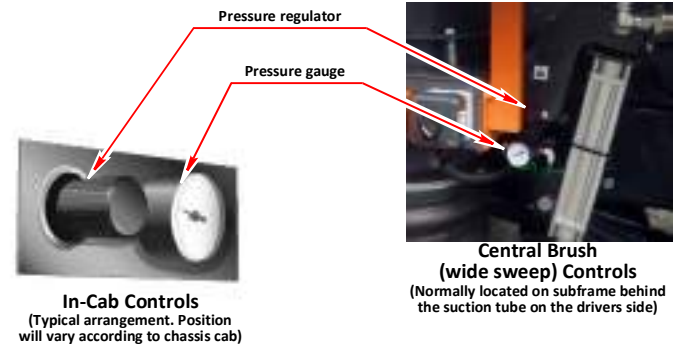

In-Cab Controls
(Typical arrangement. Position will vary according to chassis cab)

Central Brush (wide sweep) Controls
(Normally located on subframe behind the suction tube on the drivers side)

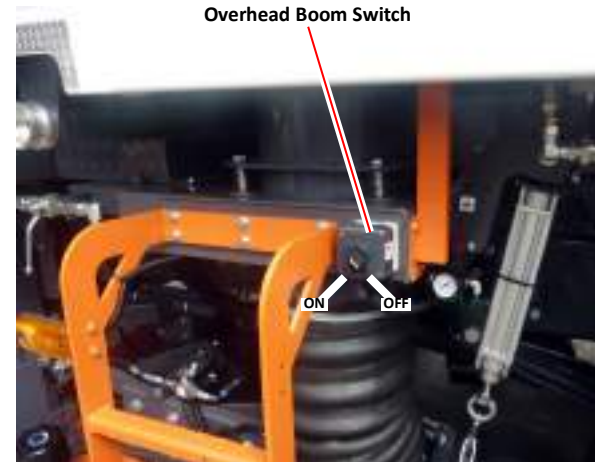

Operating In Sweep Mode

i Refer to Health and Safety Advice on page 10.

i **Reducing Noise Levels and Fuel Consumption** - Although it is important to always operate within the engine's optimum speed range, there are times when it is possible to reduce engine speed to the lower end of this, thereby reducing noise levels. This is most beneficial when sweeping at night, or areas which are sensitive to noise pollution. Sweeping at reduced engine speeds can be achieved most satisfactorily when sweeping light or sparsely distributed materials. Experience will enable the operator to vary engine speed, according to sweeping conditions, without affecting sweeping performance. It should be noted that the operator benefits from reduced noise levels in the cab and that any reduction in engine speed, also results in a corresponding reduction in fuel consumption.

Starting the Auxiliary Engine

When the machine's ignition is turned on the following events occur:

- The CAN Bus system checks that all control nodes are present and functioning correctly.
- The LCD Monitor turns on and for a few seconds displays a Scarab logo (splash) screen.
- The LCD Monitor then displays a simplified graphic of the truck, the time and auxiliary engine speed.

i If an error is detected at this stage the 'Fault Active' symbol  will be displayed on the LCD monitor. To identify the error, refer to the Options Screen menus 'Driver's Fault Codes' on page 44.

To start the auxiliary engine:

1. Press and hold down the 'System Start/Stop Sweep Mode' button  until the auxiliary engine starts. When the auxiliary engine starts its default idle speed of 950 rpm will display in the top right of the LCD monitor.
With the auxiliary engine running, the system is now effectively in Sweep Mode and a number of symbols representing the installed sweeping equipment will appear superimposed over the truck graphic on the LCD monitor.
2. On the control panels, select the desired sweeping equipment. Refer to pages 14, 15 and 16 for more information.

i The auxiliary engine speed will increase if the following functions are selected:-
Suction Fan and/or High Pressure Water Pump*, auxiliary engine speed rises to 1200 rpm.
Suction Fan Boost, auxiliary engine speed rises to 1700 rpm.





Note: * = Option

Suction Fan Boost

When required a boost setting is available for the suction fan. This increases the fan speed and is used when sweeping heavy material. To operate the fan at the boost setting carry out the following procedure:

1. With the suction fan running press the boost switch . Please refer to page 16.

Sweeping

1. Switch on the hazard warning beacons.
2. Switch on the suction fan . The suction fan symbol on the LCD monitor will change from white  to green . See page 14.
3. Select the desired configuration of brushes/suction nozzles and water sprays, any combination of brushes and water can be selected, either by pressing each switch required or the Favourite Setting switch  to recall your saved settings, if you have saved that previously. See page 15 and 16.
4. Switch on work lights  if required. See page 16.

5. Move the multi function lever, which is located on the auxiliary control panel to the ON position to start and deploy the pre-selected sweeping equipment.

To stop and stow the sweep gear, return the multi function lever to the OFF position. The sweeping equipment will stop, raise to the stowed position and all water spray jets will stop. This also occurs automatically when the vehicle is put into reverse gear and will revert back when reverse is disengaged. See page 16.



6. Operate the multi function lever left or right positions to swing the side brushes in and out. See page 16.

On right hand drive vehicles move the lever to the right to swing the side brushes out and move the lever to the left to swing the side brushes in.

On left hand drive vehicles move the lever to the left to swing the side brushes out and move the lever to the right to swing the side brushes in.

7. Operate the multi function lever in the back/downward position to temporarily tilt the suction nozzles to allow larger items to be removed from the swept surface. See page 16.
8. Select the forward gear ratio best suited to the prevailing sweeping conditions and commence sweeping.

 The multi function lever will return to the ON position after using the side brush or nozzle tilt functions.



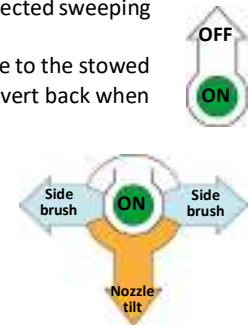

 If considered appropriate reduce/increase the auxiliary engine speed to suit the prevailing sweeping conditions, by using the engine speed switches   on the main control panel. Engine speed can only be adjusted between its minimum effective speed for the situation and the active preset default speed. Auxiliary engine speed cannot be adjusted when 'Suction Fan Boost' is in operation.

 **Be aware that too much reduction of engine speed can adversely affect suction performance.**

 **Whatever the situation, remember that the rules of traffic and road safety must be observed.**



Exiting Sweep Mode/Stopping the Auxiliary Engine

1. Switch off the suction fan , located on the main control panel. The suction fan symbol on the LCD monitor will change from green  to white .
See page 14.
2. Move the multi function lever, located on the auxiliary control panel, to the OFF position. All active sweep system will stop and retract.
-  *If the multi function lever is not returned to the OFF position at this point, the sweeping equipment will not function upon any subsequent resumption of sweep mode until it has been first returned to the OFF position and then moved to the ON position.*
3. Allow the auxiliary engine to idle for approximately two minutes and then press the 'system start/stop, sweep mode' button . The engine will stop and the sweeping equipment symbols displayed on the LCD monitor truck graphic will not be shown, showing that sweep mode is OFF.



Discharging the Hopper (Tipping)







⚠ Before raising the hopper ensure that the machine is on firm, level ground and there are no overhead obstructions.

Ensure that all personnel are clear of the rear door and there is enough room for it to open fully.

Ensure that the suction fan has been switched off. See page 16.

When the hopper is in the fully raised position ensure that the hopper safety prop has properly deployed.

To discharge the hopper proceed as follows:

1. Ensure the machine correctly positioned in the discharge area.
2. Turn vehicle engine off. Parking brake engaged. Vehicle in neutral.
3. Multi function lever off. See page 16.
4. Auxiliary engine on. See page 20.
5. The safety interlock button  needs to be pressed and held in while using other buttons on the remote control.
6. Open rear door by pressing and holding  until fully open.
7. Raise the hopper fully by pressing and holding .
8. With the load fully discharged. Press and hold , check that the hopper safety prop has retracted back away from the hopper, continue pressing  until the hopper is completely lowered.
9. Insert the rear door safety prop. See page 13.
10. Ensure that the rear door seal and its mating surfaces on the hopper are free from any foreign matter that might damage the seal or adversely affect the sealing function.
11. Remove and stow the rear door safety prop.
12. Close rear door by pressing and holding  until it has fully closed and the door locking mechanism has fully engaged.
-  Door cannot be closed until hopper has been fully lowered. See page 24.**
13. Start the vehicle and move it clear of the discharge area.



Ensure the hopper safety prop has completely deployed when the hopper is in the raised position.

Never work under a partially raised hopper or if the hopper safety prop is not fully deployed.





Rear Door Operation

⚠ Ensure that all personnel are clear of the rear door and there is enough room for it to open fully.

Ensure that the suction fan has been switched off. See page 16.

When working with the door in the fully raised position ensure that the door safety prop has properly deployed.

To open and close the rear door, proceed as follows:

1. Ensure the machine correctly positioned with plenty of room for door to open fully.
2. Turn vehicle engine off. Parking brake engaged. Vehicle in neutral.
3. Multi function lever off. See page 16.
4. Auxiliary engine on. See page 20.
5. The safety interlock button  needs to be pressed and held in while using other buttons on the remote control.
6. Open rear door by pressing and holding  until fully open.
7. Insert the rear door safety prop if working around or under the rear door.
8. Ensure that the rear door seal and its mating surfaces on the hopper are free from any foreign matter that might damage the seal or adversely affect the sealing function.
9. Remove and stow the rear door safety prop.
10. Close rear door by pressing and holding , the auxiliary engine speed will raise to 1500rpm, the auto blanking flaps will close and the suction fan will switch on. Continuing holding  until the rear door has fully closed and the door locking mechanism has fully engaged.

Releasing the close button will switch off the suction fan and engine speed will fall to tick-over after a small delay.

This has been done to create a vacuum in the hopper which will help close and seal the rear door.

i *The rear door will not close via the remote control unless the hopper is in the fully down position as determined by the hopper down sensor.*

Rear Door Prop

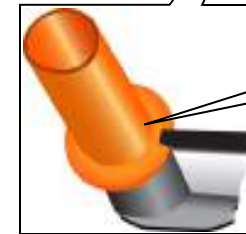
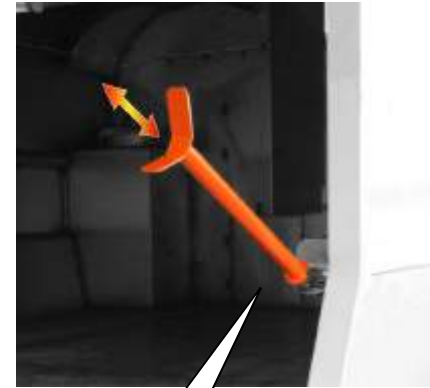



When inserting the door prop, ensure it is correctly positioned in the locating slot.

Auxiliary Hand Pump

The auxiliary hand pump is used to raise the hopper or open the rear door if the auxiliary engine has failed, hydraulic pump is not working or there is electrical failure on the machine.

Proceed as follows if there is electrical power available on the machine:

1. Vehicle engine off. Parking brake engaged.
2. Switch the ignition on. Do not start the vehicle engine.
3. Insert the pump handle.
4. Press and hold the safety interlock button  and either the hopper raise  or door open  button.
5. While the above buttons are being held operate the hand pump handle (5). See illustration to the right.

If electrical power is unavailable on the machine then proceed as follows:-

1. To raise the hopper depress the locking button (1) and pull out the control ring (2).
To lower the hopper, ensure that the hopper safety prop is not in the deployed position, then depress the locking button (1) and push in the control ring (2).
See illustration to the right.
2. To open the rear door depress the locking button (3) and pull out the control ring (4).
To close the rear door, ensure that the rear door safety prop has been removed and stowed, then depress the locking button (3) and push in the control ring (4).
See illustration to the right.
3. Operate the hand pump handle (5).



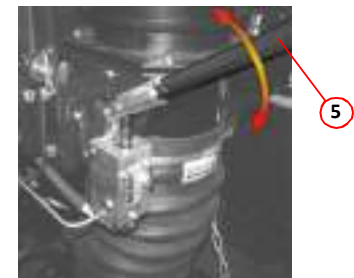
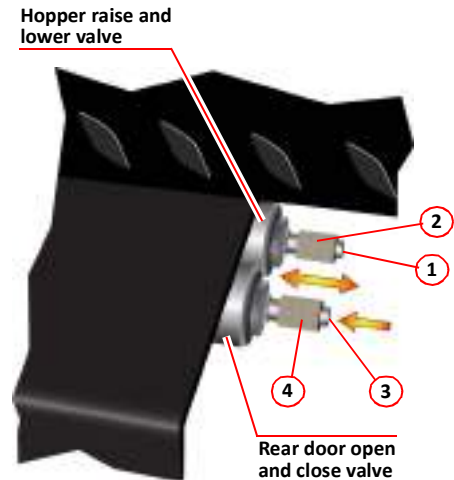

The hopper safety prop should always be in the deployed position when the hopper is in the raised position. Failure to do so could result in serious injury. See page 13.
Rear door safety prop should also be deployed if working beneath it and the rear door is open.



Wander Hose

The wander hose is permanently mounted on the rear of the vehicle. The weight of the hose and nozzle are supported by a gas strut attached to the boom assembly.

To use the wander hose proceed as follows:

1. Vehicle engine stopped and handbrake on.
2. Auxiliary engine on. Sweeping equipment deselected and stowed. Ensure the suction fan is off .
3. Demount the suction tube from its stowage position and swing the whole unit to the required position.
4. Turn the suction fan on .
5. Use the suction tube as required.
6. For situations requiring maximum suction i.e. when removing stubborn objects etc., then press the suction fan boost button .
7. When replacing the wander hose, make sure that the boom is over the stowage tube. Ensure that the suction tube is correctly fitted into its blanking cap. Failure to do so will adversely affect suction when sweeping.

Inspection Hatch

To perform a quick visual inspection of the hopper interior and the fan filter screen, a hatch has been installed in the rear door and is accessed via an access ladder attached to the rear door.

Proceed as follows:

-  **The vehicle must be off and ignition keys removed and the parking brake engaged.**

Always exercise extreme caution when opening the hatch as debris could have built up behind it.

1. Lower access ladder by releasing the catch and then swinging down the access ladder.
2. Turn handle on door to unlatch and carefully pull door open.
3. Visually check the hopper interior and the fan filter screen.
4. Close door, close latch. Raise access ladder and fasten with the catch.

-  **Ensure that all items on the rear door are stowed and door is in the closed and latched position before driving vehicle away.**

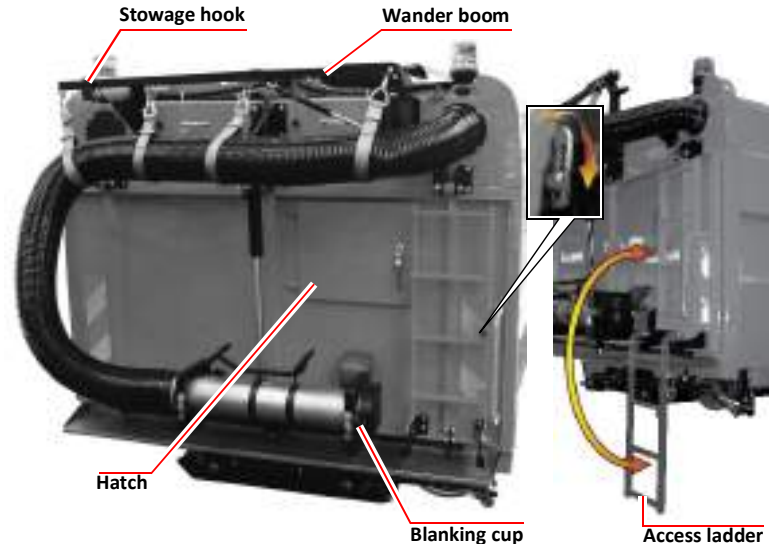

Overhead Boom

C *The following can not be done with the suction fan ON.*

Assembly of overhead boom

1. Open the locker door on the side of the hopper that the overhead boom is located.
2. Insert the door stay.
3. Lift the and remove the first extension tube from the door, turn it over and stand it on the ground nearby.
4. Holding onto the sprung clips at the bottom of the overhead boom, open them to release from its blanking plate. Do not let go. Manoeuvre the overhead boom from its storage hook, swing it out and attach to the extension tube using the sprung clips. The overhead boom can now be released and it should be weighted to just touch the ground.
5. Release the rubber tieback from the second extension tube which was located behind the overhead boom in the locker.
6. Lift and remove the second extension tube and locate it next to the overhead boom and already attached extension.
7. Lifting the overhead boom with the first extension; lowering it onto the second extension tube. Ensure that both the spring catches on the second extension tube are connected to the bottom of the first extension tube.
8. The overhead boom is now assembled and ready to use.

i *See page 19 for details on using the overhead boom controls to enable extra suction and water for the overhead boom.*

Stowing the overhead boom

The stowage procedure is the reversal of the above procedure.



Overhead boom locker
First extension stowed on locker door



Open sprung clips to release
from blanking plate



Slide and unhook to release



First extension attached,
second ready to attach



Second extension attached
with spring catches in place



Overhead boom ready to use

Dust Suppression System

Use of the low pressure water spray, dust suppression, system when sweeping, will reduce the amount of dust generated and ensure a more efficient collection of material. This is because wet material is heavier and will drop more readily from the air stream in the hopper. If swept dry material will pass through the fan filter screen, wearing out the suction fan blades on its way back out to the environment behind you.

Water Tank Filling

Attach the appropriate coupling and water hose to the filler aperture (1) situated in the right hand tool locker, and using clean water, fill until the blue float reaches the top of the water level sight tube (2) situated on the left hand side of the machine.

Low Pressure Water System

The low pressure water is used on the, side brush(es), suction nozzle(s), and central (wide sweep) brush. To operate any of these functions the relevant button(s) on the main control panel, see page 15, must be selected when in sweep mode.

A shut-off valve (3) is positioned between the tank water strainer and must be open when the system is in use or when draining the system.

The side brush(es) are fitted with shut-off valves (4).

⚠ It is vital that the water system is drained totally if the air temperature is expected to fall to 0°C or lower. In frosty weather leave the hopper slightly raised with the rear door partially open.

Draining the System



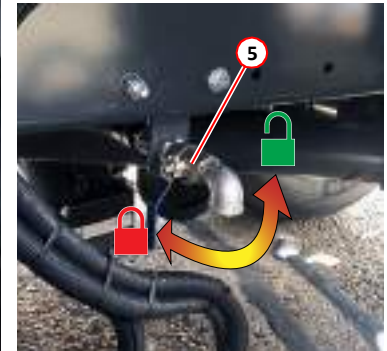
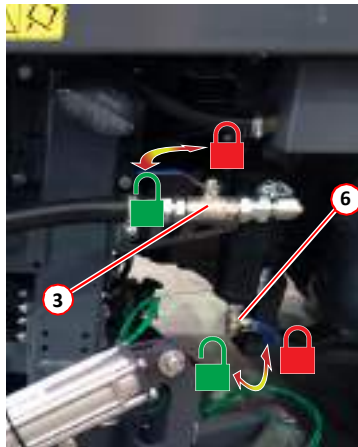
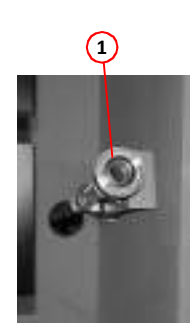
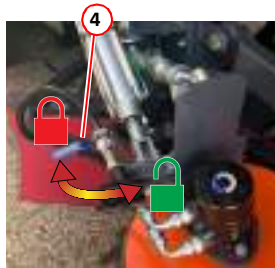

Open water tank drain valve (5) and open drain valve on water strainer (6).

⚠ The hydraulic driven water pump should NEVER be permitted to run dry.

i Due to customers requirements, other water features may be present but not mentioned in this publication.



High Pressure Water System

- ⚠ High pressure water can be dangerous, always wear goggles or suitable eye/face protection.    **
- Exercise extreme care when using the lance, do not direct the jet towards yourself, other people or electrical equipment.**
- Failure to comply could result in serious injury.**

High pressure water is optional and is used with the following components:

- Front spray bar, not shown, and its valve **(1)**.
- Hand lance **(2)** and retractable hose **(3)**, which are always located on the kerbside of the vehicle.

To operate any of the above options use the following procedure:-

- The auxiliary engine must be started **(D)**. See page 15.
- Open the appropriate valve(s) for the function required. See illustrations to the right.
- Press the **H** on the auxiliary control panel. See page 16.

Retractable Hose

The hand lance **(2)** is attached to a 13 metre long rubber hose fitted to a hose reel **(3)**. When extending the hose, a ratchet mechanism allows the reel to lock in place. Further extending past the ratchet allows the reel to retract. The position of the hose reel and hand lance are located on the kerbside of the vehicle.

- ⚠ It is vital that the water system is drained totally if the air temperature is expected to fall to 0°C or lower.**
- In frosty weather leave the hopper slightly raised with the rear door partially open.**

Draining the System

Open water tank drain valve, see page 28, and open drain valve on water strainer **(4)**, open pump drain valves **(5)** and **(6)**.

- ⚠ The hydraulic driven water pump should NEVER be permitted to run dry.**

Hose reel



Front spray bar valve

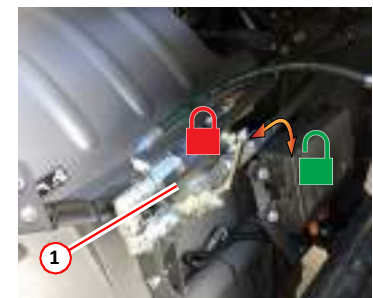

Hand lance



High pressure pump

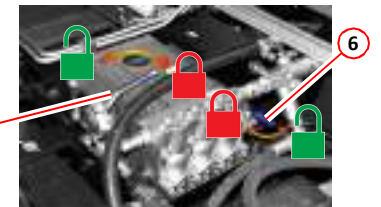

Suction Path Blockage Clearance

 **Always wear appropriate personnel protective equipment (PPE).**    

A blockage in the suction path will be indicated by a trail of material behind the vehicle. The most likely cause is an obstacle either in the suction nozzle, or the trunking immediately above it, around which other material collects as sweeping progresses. It is important that such problems are rectified as soon as possible.

Before this can be achieved, however, the following health and safety concerns must be addressed. These are important and are intended to maintain safe working conditions at all times, therefore:-

-  **Never raise the hopper where the load it contains or the ground you are on could cause the machine to become unstable.**
- Never attempt to work beneath a partially raised hopper, i.e. where the safety prop cannot be deployed.**
- Never attempt to clear a blockage while the brushes are operating, always stop and retract all brushes, stop the engine and remove the ignition keys before starting the procedure.**
- Always be aware of the risk from sharp objects and never place your hands into the blockage, even when wearing gloves. Exercise extreme caution when handling any items removed from the suction system, keeping such activities to the absolute minimum.**

Only when all of the foregoing points have been complied with, should the clearance procedure commence. If it is not possible to comply with these conditions you are advised to consult your supervisor before acting.

The procedure for checking and clearing the blockage is as follows:

1. Raise the hopper, ensuring the hopper safety prop is deployed, to gain access to the top of the suction tube.
2. Visually check conditions inside the suction tube and nozzle box to determine the nature and location of the blockage and whether, without suction, the blockage has dropped back to the road surface.
3. If the blockage is still present, use a suitable implement (a stout length of wood is ideal), to remove the obstacle by pushing it downwards.
4. Once the offending item has been successfully removed, restart the Machine and use the high-pressure hand lance, if fitted, to thoroughly wash out the trunking and nozzle box,
5. Lower the hopper, ensuring that the hopper safety prop has retracted, but do not start the suction fan at this stage.
6. Move the vehicle sufficiently to expose the cause of the blockage. Stop the Machine, apply the parking brake and remove the ignition key. Carefully isolate the blockage and remove to a safe location.
7. Resume sweep mode. Lower the suction box and switch on the fan. Assure the suction is correctly functioning.
8. Return to the start of the trail created by the blockage and continue sweeping.

Diagram showing the area to most likely to suffer a blockage.

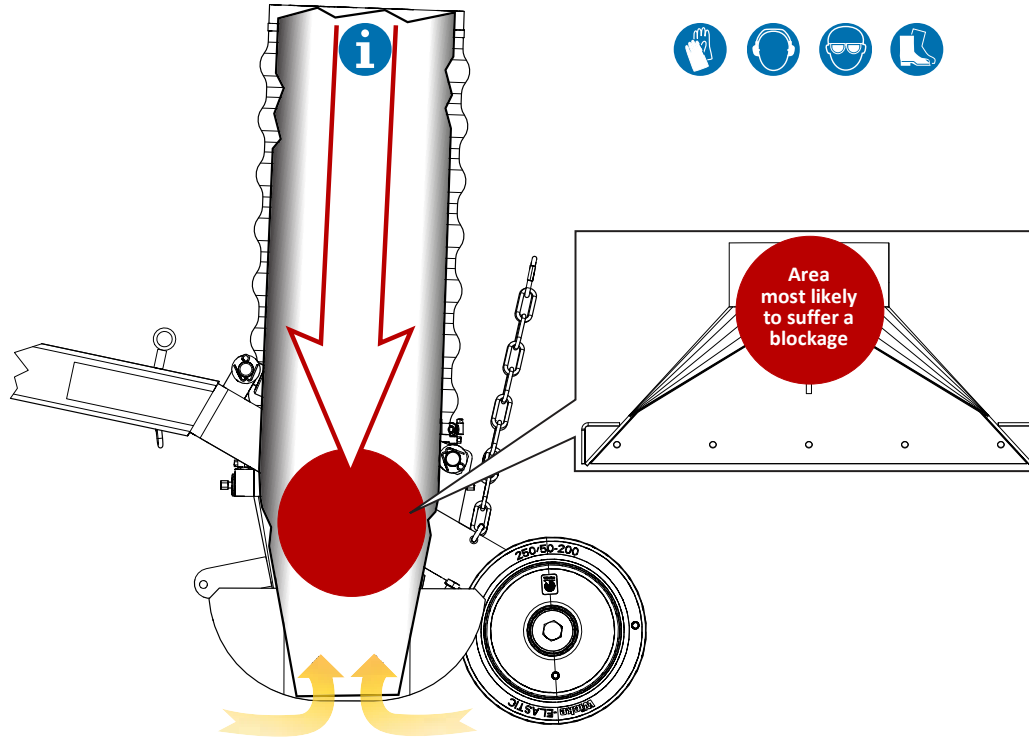

Recommended Operator Routine Maintenance

 **Always wear appropriate personal protective equipment (PPE).**     

It is important that the following routine maintenance procedures are carried out as directed. This will help to ensure that your Scarab sweeper performs at the optimum level of safety and efficiency. Refer to the pages immediately following this schedule and to the Table of Contents for more detailed information. For chassis servicing/maintenance, refer to the manufactures information.

| | Maintenance Procedure | Daily Actions Before Use/After Use | | Weekly |
|----|---|------------------------------------|---|--------|
| | | | | |
| 1 | Check vehicle/body for safety. All lighting equipment, tyres, fuel, oil, coolant, brake fluid, windscreen wash and water tank level. | ✓ | ✗ | ✗ |
| 2 | Check auxiliary engine, fuel, oil and coolant levels | ✓ | ✗ | ✗ |
| 3 | Check hydraulic oil level and inspect system for signs of leaks. Check oil cooler is clean. | ✓ | ✗ | ✗ |
| 4 | If vehicle not previously used by YOU, check suction fan is clean. | ✓ | ✗ | ✗ |
| 5 | Check brushes/skirts for wear or damage. Remove entangled items, e.g. string and strapping, etc. | ✓ | ✗ | ✗ |
| 6 | Check suction nozzle flaps for damage/correct ground clearance. | ✓ | ✗ | ✗ |
| 7 | Check water spray jets for blockages. | ✓ | ✗ | ✗ |
| 8 | Check that all equipment is securely stowed and brushes are retracted. | ✓ | ✗ | ✗ |
| 9 | Wash vehicle, particularly hopper screen, surrounding ledges and area above. Leave hopper door partially open, to allow air to circulate. | ✗ | ✓ | ✗ |
| 10 | Wash oil cooler, ensuring that the fins are clean. | ✗ | ✓ | ✗ |
| 11 | Lubricate as appropriate, all brush links, pivot. | ✗ | ✓ | ✗ |

| | Maintenance Procedure | Daily Actions Before Use/After Use | | Weekly |
|----|--|------------------------------------|---|--------|
| | | | | |
| 12 | Remove/clean the low pressure and high pressure water filter elements. | ✗ | ✓ | ✗ |
| 13 | Clean the suction fan thoroughly, using the scraper provided and high pressure water. See page 33. | ✗ | ✗ | ✓ |
| 14 | Grease hopper ram (Top and bottom). | ✗ | ✗ | ✓ |
| 15 | Visually check entire machine for wear/damage. | ✗ | ✗ | ✓ |
| 16 | Check wiring and hoses for security of attachment and signs of wear and/or damage. | ✗ | ✗ | ✓ |
| 17 | Check wear in suction tubes and deflectors in hopper. | ✗ | ✗ | ✓ |
| 18 | Check seals on hopper door, rear hatch and suction tubes. | ✗ | ✗ | ✓ |
| 19 | Check oil level in high pressure water pump, top up if needed. | ✗ | ✗ | ✓ |
| 20 | Grease all points. See page 40. | ✗ | ✗ | ✓ |

 *The foregoing are general recommendations only. Requirements vary from territory to territory and depend on vehicle usage/operating conditions. IF IN DOUBT, CONSULT YOUR NEAREST SCARAB DEALER.*

Key Maintenance Procedures

Cleaning the Suction Fan and Screen





⚠ Failure to comply with the following could result in serious injury.

Before working on the machine position it on firm, level ground and apply handbrake.

The fan is an extremely heavy rotating mass. Never attempt to slow or stop its rotation by using the hands or by inserting any item into the fan chamber, even at low speeds.

Never work under a raised hopper without the hopper safety prop being deployed.

Procedure to clean the fan and screen is as follows:

1. Turn engines off and remove ignition keys.
 2. Use a suitable platform to reach the area above the rear door.
 3. With the fan stationary, remove the outer and inner inspection covers from the hopper to expose the fan.
 4. Using the special scraper, thoroughly clean all parts of the fan. A steam cleaner or high pressure water from a remote source will greatly assist in cleaning severely contaminated fans.
 5. Refit the inspection covers.
 6. Restart the auxiliary engine , see page 20, and using the remote open the rear door , see page 17.
 7. Insert the rear door safety prop. See page 13. Turn off auxiliary engine and remove ignition keys.
 8. Lower the suction fan filter screen, wash the screen using a steam cleaner or high pressure water from a remote source. Raise and secure the screen.
 9. Ensure that the rear door seal and its mating surfaces on the hopper are free from any foreign matter that might damage the seal or adversely affect the sealing function.
 10. Remove and stow the rear door safety prop.
 11. Using the remote to close the rear door , see page 17.
- ⚠ Loose particles from the cleaning process can be ejected via the hopper cover when the fan is restarted, ensure that all personnel are clear before restarting.**
12. Restart the auxiliary engine , see page 20 and switch the suction fan on , see page 16.
 13. If the sweeper has a rear inspection hatch and with the rear door shut and suction fan running, carefully open the inspection hatch, direct additional water onto the suction fan screen just below the inlet cone until clean water is being expelled from the fan case/hopper cover.

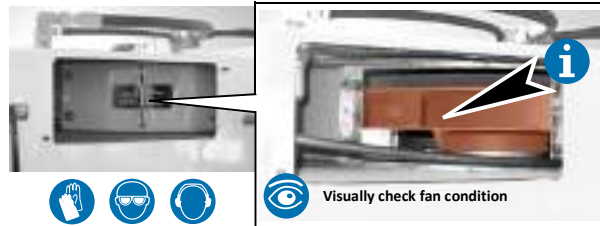

PLEASE PAY PARTICULAR ATTENTION TO INNER CURVE OF BLADE AND ALSO THE CENTRE OF THE UNIT WHERE DIRT ACCUMULATES AROUND THE HUB AREA

Auxiliary Engine

i *The auxiliary engine is the responsibility of the operator, as is the chassis engine. The following instructions should be followed as detailed in the maintenance schedule on page 32 and in the manufacturer's recommendations.*

Engine Access

To access the engine the hopper needs to be raised, see page 23. Use of the access steps and grab handle is recommended. The engine bay work light is operated by the green switch (1) on the side of the electrical/pneumatic cabinet. When pressed it starts a timer for 30 minutes and then switches off. Pressing the button again restarts the timer. This light works independent of the ignition circuit.



- ⚠ Failure to comply with the following could result in serious injury.**
- Never work under a raised hopper without the hopper safety prop being deployed.**
- When mounting the chassis always use the access steps and tread plates. Ensure they are free from contamination that may cause them to become slippery. Always wear suitable footwear with clean and dry soles.**
- Wear appropriate personnel protective equipment (PPE).**

⚠ Ensure that the machine is on a flat and level surface with the auxiliary engine stopped for a suitable period, to allow the oil to return to the sump and cool sufficiently.

Engine Oil

To check the engine oil proceed as follows:

1. To access the engine the hopper needs to be raised, see instructions on page 23.
2. Remove the dipstick (2) from the holder.
3. Wipe clean with a lint free cloth.
4. Replace in holder. Remove again and check the oil level.

⚠ The oil level should never fall below the minimum level or exceed the maximum level as shown by the gauge on the bottom of the dipstick. The oil level should be within the chequered indented area of the dipstick (3).

5. If extra oil needs to be added then remove the filler cap (4) next to the oil filter and dipstick or remove filler cap (5) on top of engine and pour fresh oil through the opening. Remember to allow time for the oil added to drain into the sump before rechecking the oil level again.

Repeat until correct level is obtained.

6. Replace filler cap and dipstick.

i Engine Oil: 15w/40.

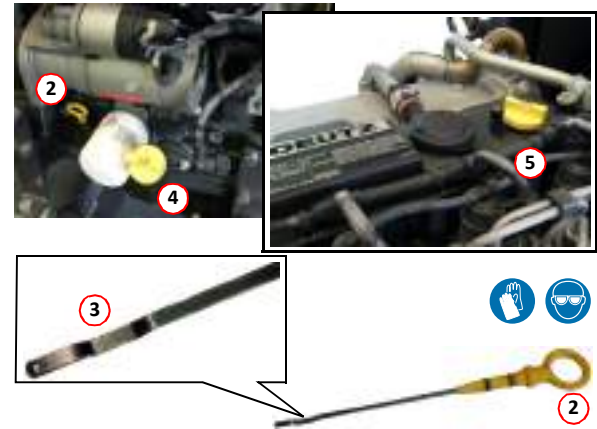

Engine Coolant

To access the engine and the coolant expansion tank the hopper needs to be raised, see instructions on page 23.

- ⚠ Failure to comply with the following could result in serious injury.**
 - Never work under a raised hopper without the hopper safety prop being deployed.**
 - When mounting the chassis always use the access steps and tread plates. Ensure they are free from contamination that may cause them to become slippery. Always wear suitable personnel protective equipment (PPE) and suitable footwear with clean and dry soles.**
 - If topping up is required when the coolant is hot adequate precautions must be taken, as an overpressure will have built up in the system.**
- ⚠ Ensure that the machine is on a flat and level surface with the auxiliary engine stopped for a suitable period, to allow the engine and coolant to cool sufficiently.**

The coolant expansion tank is fitted with a low level sensor that will flash the 'Fault Active' symbol **⚠** on the LCD monitor and pulse the warning buzzer. The operator should then further investigate via the diagnostics screen on the LCD monitor.

To check and top up the coolant fluid use the following procedure:

1. Remove the filler cap **(1)** from the expansion tank.
2. Run the engine for several minutes.
3. Stop the engine.
4. Check the coolant level using the sight glass **(2)** on the side of the expansion tank.
The coolant level should be within the sight glass and ideally level with the dot in the centre of the sight glass.
5. If required top up coolant to the required level using the correct coolant mixture.
6. Replace the filler cap.

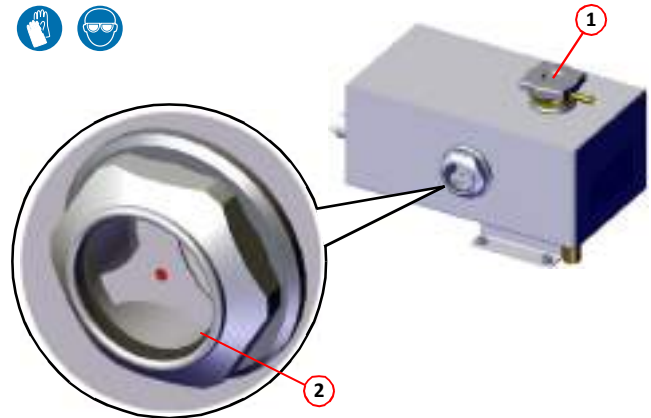



i Coolant: Ethylene Glycol (Eskimo Long Life).
Mixture 50/50 to ASTM D 4985.

Hydraulic Oil Tank

The hydraulic oil tank is accessed via the left hand gantry door.

⚠ Always wear suitable personnel protective equipment (PPE).

⚠ Ensure that the machine is on a flat and level surface with the auxiliary engine stopped for a suitable period, to allow the engine to cool sufficiently. It is advisable to top up the hydraulic oil level when the system is cold.

The hydraulic oil tank gauge is fitted with a low level sensor which will display  and the 'Fault Active' symbol  on the LCD monitor and buzzer will sound and the sweep gear will be lifted. The operator should then further investigate the problem.

To check and top up the hydraulic oil use the following procedure:

1. Open left hand gantry door.
2. Using the gauge to the side of the sight glass **(1)** check the oil level. Ensure you use the correct part of the gauge depending on if the hopper is raised or lowered.
3. Use the appropriate sized spanner to undo and then remove the filler cap **(2)**.
4. Top up to the correct level using Renolin B10 VG 32 or equivalent hydraulic oil.
5. Replace filler cap and tighten bolt.
6. Close the left hand gantry door.

i Hydraulic Oil: Fuchs Renolin B10 VG 32

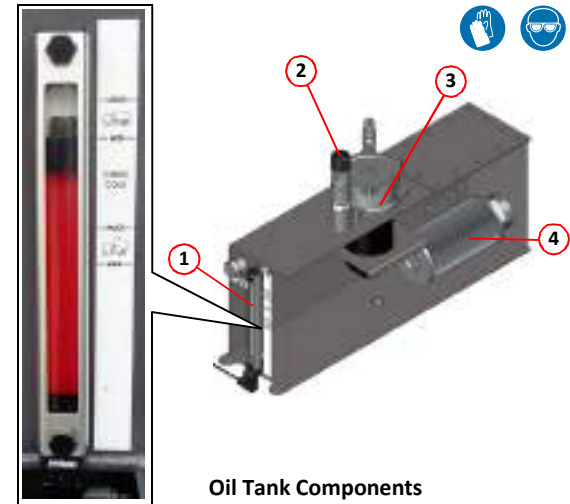

Oil Tank Components

- (1)** Sight glass/gauge.
- (2)** Oil filler cap.
- (3)** Return filter.
- (4)** Suction filter.

Filling the Fuel Tank

⚠ *Ensure that the machine is on a flat and level surface before checking the fuel level.*

The DEUTZ TCD 3.6 EU Stage IIIB engine uses ultra low sulphur diesel fuel to EN590.

1. To check and fill the fuel tank use the following procedure:
2. Open left hand gantry door.
3. Use the sight glass **(1)** to determine the level of fuel within the tank.
4. If you need to add fuel to the tank then using the key supplied, unlock and remove the filler cap **(2)**.
5. Insert fuel filler nozzle into the opening and fill as required keeping an eye on the sight glass.
6. Once the required level of fuel has been reached remove the nozzle.
7. Replace and lock fuel filler cap.
8. Close the left hand gantry door.

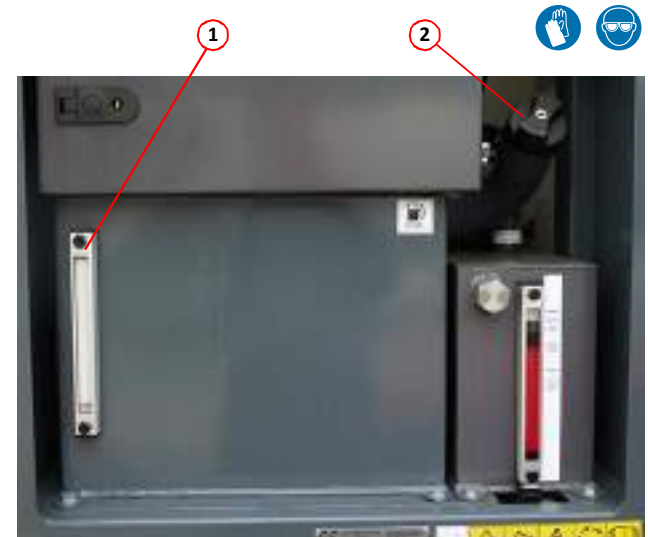

Suction Nozzle Clearances

Inspect the suction nozzle flaps to verify that they are in good condition and do not show excessive wear. Adjust as necessary to achieve the correct flap to ground clearances. The factory settings are:

- Inboard Side Flap = 15 mm
- Front Flap = 20 mm
- Rear Flap = 15 mm

i These clearances are based on the factory setup. For some operating conditions, it might be found that, alternative clearances are preferred.

Side Brushes

⚠ Do not attempt to alter the brush settings while the brush is rotating. Before proceeding ensure that people and objects are clear of the brush area.

An effective brush set-up ensures good sweeping performance. The following settings produce excellent results in most conditions. Experience will determine if other settings are better suited to specific conditions.

1. Vehicle stopped, handbrake ON, sweep mode ON, activate the desired brush(es) in their working positions.
2. Switch OFF ignition and remove the key.
3. Locate the appropriate valve(s) in the pneumatic cabinet and activate the manual override **(1)** to allow the brush(es) to extend.
4. Adjust the top link **(2)** and/or the motor plate **(3)** until the brush is at the correct contact with the road surface. See diagram **(4)**. Re-tighten any items slackened during adjustment.
5. Re-start vehicle, stow all sweeping equipment activated for adjustment.

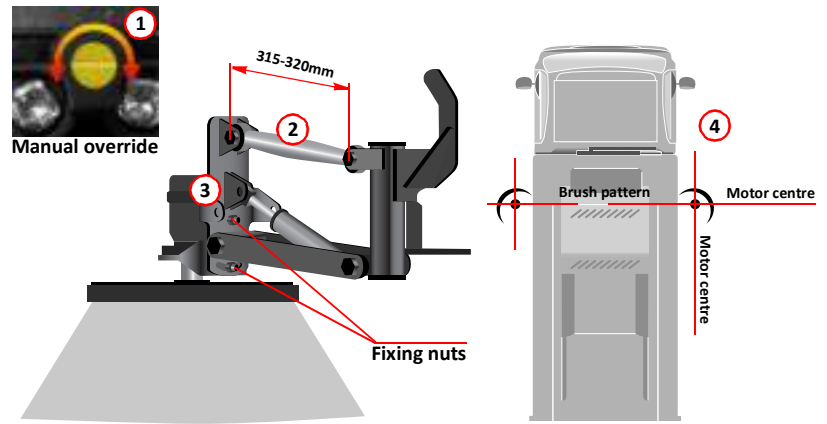

Removing and Cleaning Water Strainer Elements

Both the low-pressure and, if fitted, the high-pressure water pump are fitted with strainers to ensure that foreign matter does not enter the pump. The following steps detail the recommended cleaning procedure:-

1. Move shut off valve(s) **(1)** into the closed position.
2. Move drain valves **(2)** into the open position.
3. Unscrew the filter bowl **(3)** from the housing **(4)**.
4. Remove the element **(5)**.
5. Washout the filter bowl.
6. Washout the element with clean water or replace if it is too contaminated.
7. Before reassembling the unit, apply some grease to the o-ring **(6)** to ensure a water tight fit with the filter bowl and housing.
8. Refit the element and filter bowl tighten hand tight.
9. Close drain valves **(2)**.
10. Open any closed shut off valves **(1)**.

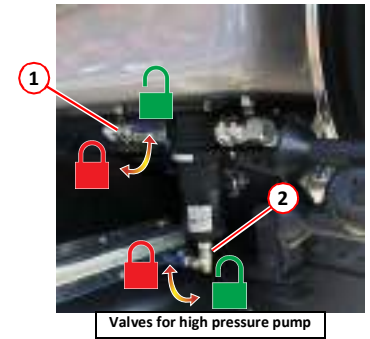
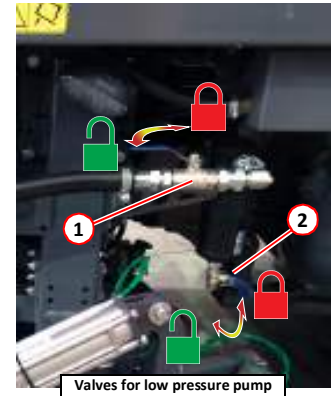
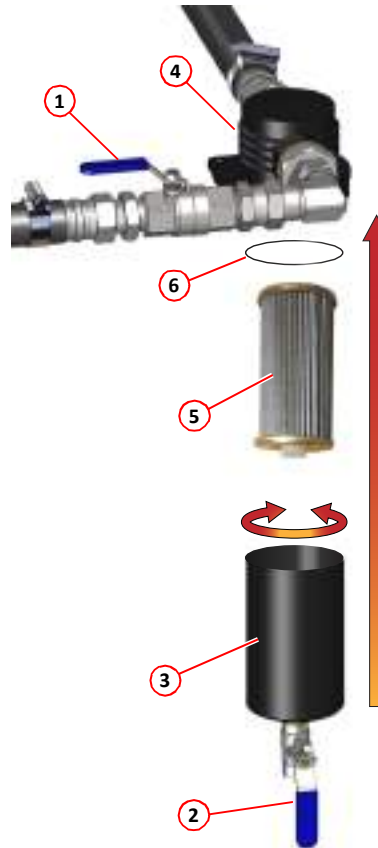

Manual Greasing and Lubrication

Carry out manual greasing in accordance with the appropriate schedule on page 32 and by referring to the accompanying diagrams shown here.

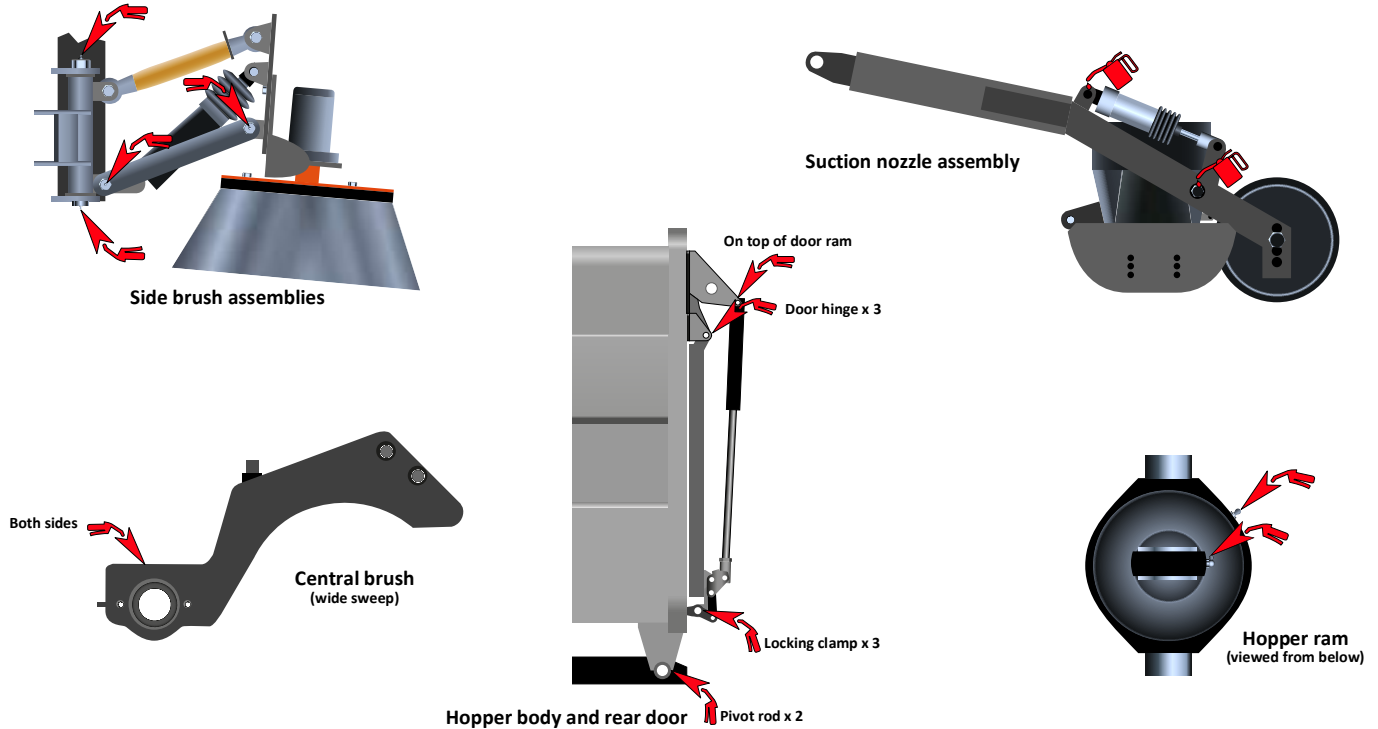

DPF regeneration

During use of the sweeper the DPF ash/soot warning symbol may appear on the Main screen. This indicates that a standstill DPF regeneration is required. DPF regeneration is the process of burning off (oxidizing) the accumulated soot from the diesel particle filter (DPF).

i *The regeneration process cannot be forced via the main screen. It can only be released if the Deutz ECU is requesting regeneration due to ash/soot load or 550 engine hours have passed since the last regeneration.*

i *The Serdia (Deutz) tool can be used to force a regeneration if desired.*

! **Ensure that the vehicle is parked somewhere safe, away from the public, with plenty of ventilation.**

DPF regeneration prerequisites

- Engine coolant temperature must be above 75°C
- Engine must be at idle
- The ECU must be requesting a standstill regeneration or is being forced by the service tool
- Enough fuel for at least 30 minutes run time.

DPF regeneration process

The operator must authorise the regeneration process by pressing the release button on the Scarab control system display. Not the truck dashboard which may have its own button for the truck engine with a similar symbol.

This can be done via any of the screens shown to the right.

Press button **(9)** from the Main screen or press button **(3)** from either the After-treatment screen or the EOL Test/Regen screen.

The regeneration process takes about 20 minutes but could be shorter or longer depending on condition of the DPF.

Button **(2)** from the After-treatment screen or EOL/Test Regen screen will cancel the Regen process.

i *For more information on how to access these screens see the section “LCD Monitor Screen” starting on page 42.*

Whilst the regeneration is active the sweeper functions are disabled, this is to allow the system to control the engine speed at a known load to carry out the regeneration efficiently.

Regeneration process completion

When the regeneration process has completed the following will happen depending on what screen you are viewing.

- The warning symbol will disappear from Main screen.
- On the After-treatment screen the Regen Status will show “Not Active”.
- On the EOL Test screen the Regen Flag will show “Regen finished successfully”.

Normal use of the sweeper is now available.

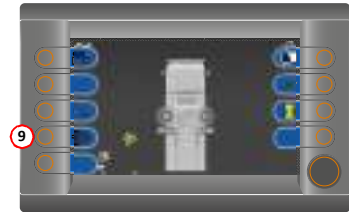

Main screen



After-treatment screen



EOL Test/Regen screen

LCD Monitor Screen

Start Up/Main/Sweep mode Screen

Button function

- (1) **Display** - Press to change the contrast of the screen (black \leftrightarrow white).
- (2) **Menu** - Press to access the menu screen (*see page 43*).
- (3) **Hours** - Press to view hours logged (*see page 44*).
- (4) **Return** - Press to return to previous screen.
- (5) **Encoder** - Turn to highlight required option, press to enter. Used in all screen modes.
Press to display side tabs from the sweeping mode screen.
- (6) **Camera** - Press to enable rear view while in forward drive.
- (8) **Hopper and Rear Door Activity Warning Buzzer** - Press to disable.
- (9) **DPF Regen** - Press to start the DPF regeneration procedure if conditions are met (*see page 41*).
(*Deutz Stage 5 engine only*).
- (10) **Options** - Press to access the options screen (*see page 51*).



Start up screen - Sweeping mode

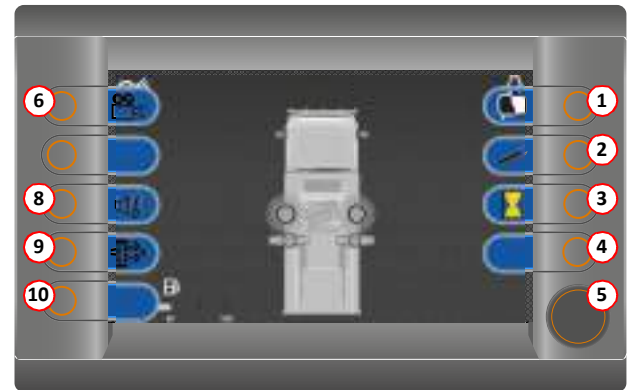

Start up screen with button tabs displayed

Menu Screen

To access the menu screen from the start up screen press button **(2)**.



Driver's fault codes (*see page 44*).



EDC - Vehicle values (*see page 47*).



Screen settings (*see page 47*).



Information (*see page 49*).



Button check (*see page 50*).



CAN menu (*Password protected*)

To select a menu item:-

- Rotate the encoder **(5)** to select the menu you require. The border of the menu item will display as red when it has been highlighted by the encoder.
- Press the encoder **(5)** when the menu you require has been highlighted.





Hours worked

Displays the working time of various functions.
 Displays fuel usage.
 Service Hours only display when activated.
 Button (4) will exit screen.



Driver fault codes

Rotate the encoder (5) to highlight either the CAN or desired Node.
 Press the encoder to select.
 Button (4) will exit screen.



CAN error screen

Identifies location of system errors.
Highlighted in red when active.

Button (4) will exit screen.



Driver fault codes

Entering a Node screen allows Pin-Contact view.
Pin numbers with an active fault are highlighted in RED.

$\text{---}/\text{---}$ = Open Circuit
 $\text{---}\text{---}$ = Short

Button (4) will exit screen.



EDC - Vehicle values

Displays the following current conditions:-
(Left to right, top to bottom)

| | | |
|---------------------|-----------------------|---------------------------|
| Engine Speed | Turbo Boost Pressure | Barometric Pressure |
| Battery Voltage | Turbo Air Temperature | Fuel Litres Used Per Hour |
| Coolant Temperature | Fuel Rail Pressure | Engine Load |
| Oil Pressure | Fuel Priming Pressure | |

Rotate the encoder (5) clockwise to take you to the after treatment screen (see page 46).

Button (4) will exit screen.



After-treatment

Displays the following current conditions:-
(Left to right, top to bottom)

| | | |
|---|------------------------------|------------------------------|
| Soot build up percentage | Exhaust temp at DOC outlet | Regeneration Status |
| Ash build up percentage | Exhaust temp at DOC inlet | Filter Status |
| Ambient temperature at air filter intake | Differential pressure sensor | Time since last regeneration |
| Warning lights - Indicator lights glow orange if active | | |

Button (2) will cancel a running regen.

Button (3) will start a regen if conditions met (see page 41).

Button (4) will exit screen.

Rotate the encoder (5) clockwise to go to the EOL Test/Regen (see page 47).

Rotate the encoder (5) counter-clockwise to go to the Vehicle values



EOL Test/Regen

Displays the status of the End Of Line Test / Regen
(Left to right, top to bottom)

| | | | |
|-------------|--|--------------|--|
| EOL Status | | EOL Feedback | |
| Regen Flag | | Time Left | |
| Ash Filter | | Oil Change | |
| Stand State | | Stand Reason | |

Button **(2)** will cancel a EOL Test/Regen if active.

Button **(3)** will start EOL Test/Regen.

Button **(4)** will exit screen.

Rotate the encoder **(5)** counter-clockwise to go to the After-treatment screen (see page 46).

Screen Settings

Highlight the desired panel using the encoder **(5)** and then press the encoder to enter the setting screen.

Button **(4)** will exit screen.



Screen Brightness Setting

Rotate the encoder (5) to adjust the screen brightness (2% increments).

Pressing the **MIN** button (3) adjusts the brightness to 10%.

Pressing the **MAX** button (2) adjusts the brightness to 100%.

Button (4) will exit screen.



Time/Date Setting

Rotate the encoder (5) to the desired panel and then press the encoder to select.

Rotate the encoder to the correct, Year, Day, Hour, etc and press the **SET** button (1).

Repeat above steps as required.

Button (4) will exit screen.



Rear Camera

Enable/disable rear camera.

Rotate the encoder (5) to select the on/off button then press the encoder to toggle on/off.

A green tick displays in the centre of screen icon when camera is activated.

i This function allows rear viewing when the vehicle is in forward drive. When reversing rear viewing will activate automatically and be displayed.

Button (4) will exit screen.

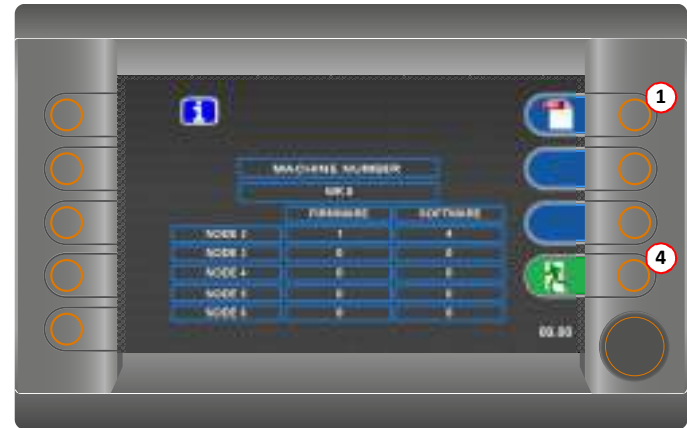

Information

Displays the machine (serial) number and current Node program version.

Press button (1) to access the PDF viewing screen. Follow the on screen directions.

⚠ Only to be used when vehicle is stationary and auxiliary engine is off.

i On exiting PDF viewer, the truck ignition must be switched off and back on again.

Button (4) will exit screen.



Button Checks

Use the encoder (5) to highlight the appropriate panel and then press the encoder.

Button (4) will exit screen.



Main Control Panel Button Check

Press the appropriate button on the main control panel.

As each button is pressed the corresponding graphic will illuminate. A beep will sound if the function is fitted.

i Illustrated to show all the buttons that should illuminate (green).
Button (4) will exit screen.

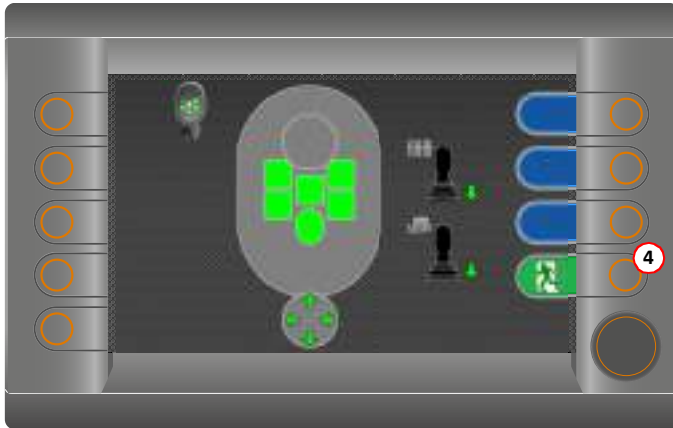

Auxiliary Control Panel Button Check

Press the appropriate button on the auxiliary control panel and move the joystick.

As each button is pressed the corresponding graphic will illuminate. A beep will sound if the function is fitted.

i Illustrated to show all the buttons that should illuminate (green).
Button **(4)** will exit screen.



Options Screen

Rotate the encoder **(5)** to select the required option, if it has been fitted, and then press the encoder to activate/deactivate.

These options are delay timers there functions are described below.

(A) This activates/deactivates the sequential brush lift option for use when the multi-function lever has been moved to the off position. Total time taken is 6 seconds to lift and retract brushes and then raise nozzle. The buzzer will “bleep” in cab to inform operator this procedure is in process.

(B) This activates/deactivates the 5 second delay for auto blanking flaps to close after the multi-function lever has been moved to the off position.

Button **(4)** will exit screen.



Operator Notes



Operator Notes



Operator Notes

Scarab Sweepers Limited
Pattenden Lane, Marden, Kent TN12 9QD

Telephone: 01622 831 006
International: +44 (0) 1622 831 006
e-mail: scarab@scarab-sweepers.com

Part No. SCAZ043468 1.6.01

Fax: 01622 832 417
International +44 (0) 1622 832 417
Web site: www.scarab-sweepers.com

E&OE